

DIBUIX TÈCNIC (SELECTIVITAT)

SPHERE

STANDARD KIT 1

2017 a 2014

SOLUCIONS

Autor: Jordi Cherta Romani

S5.3A

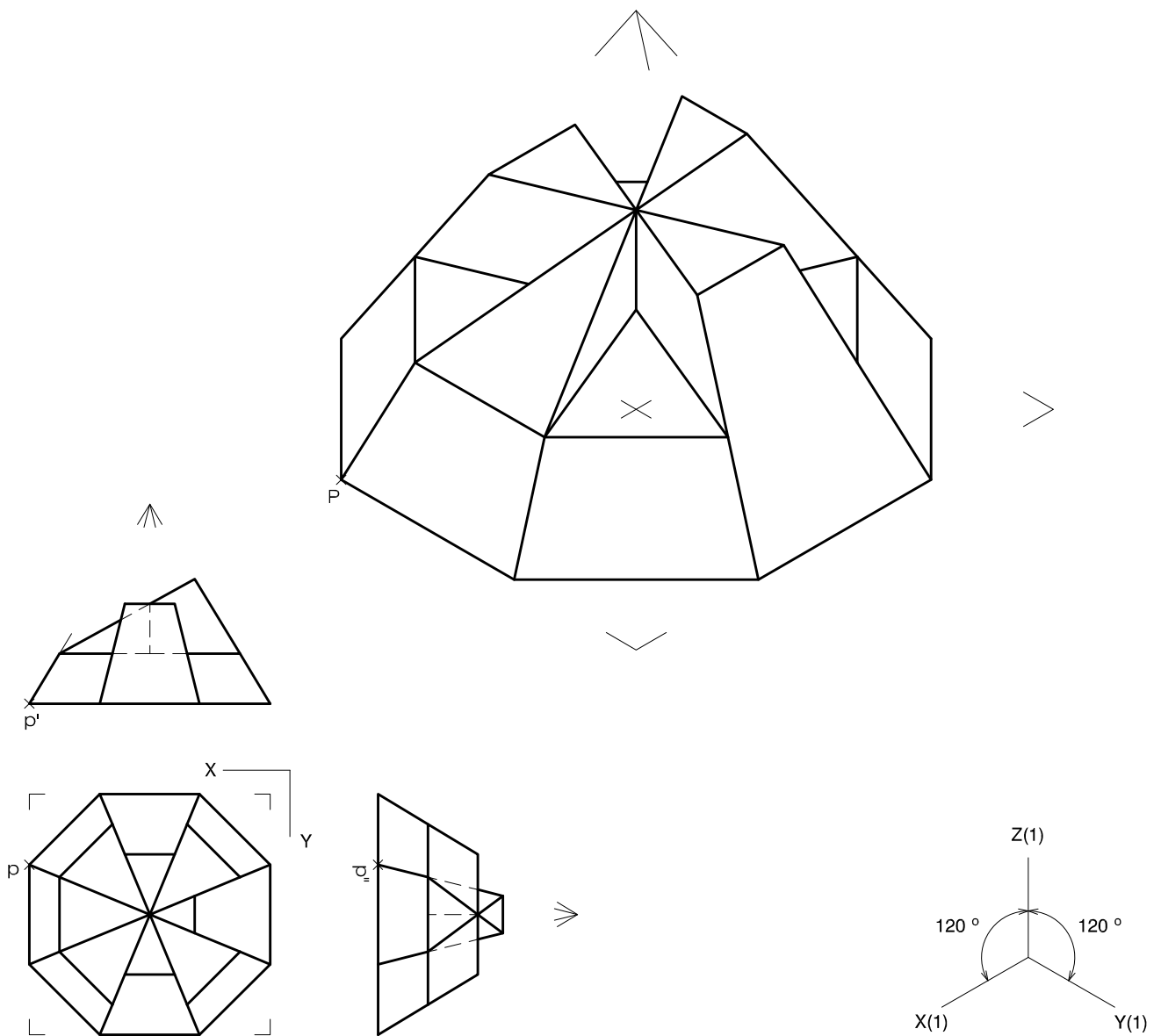
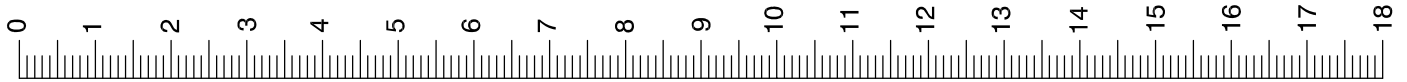

S5.3B

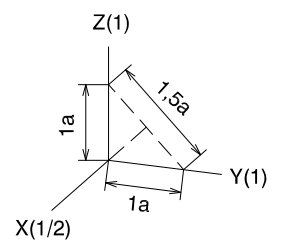
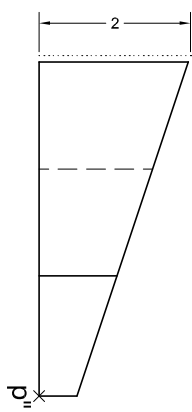
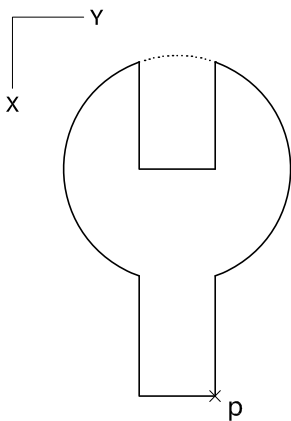
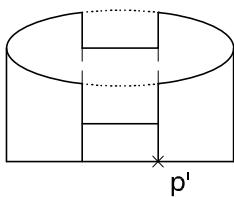
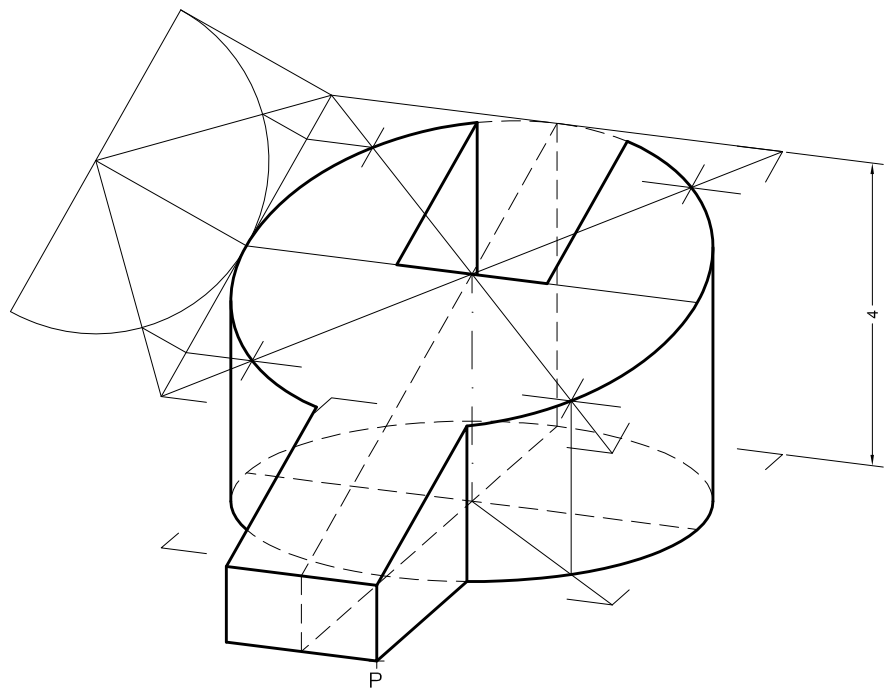
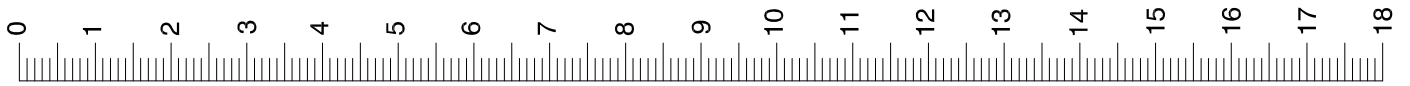

S2.3A

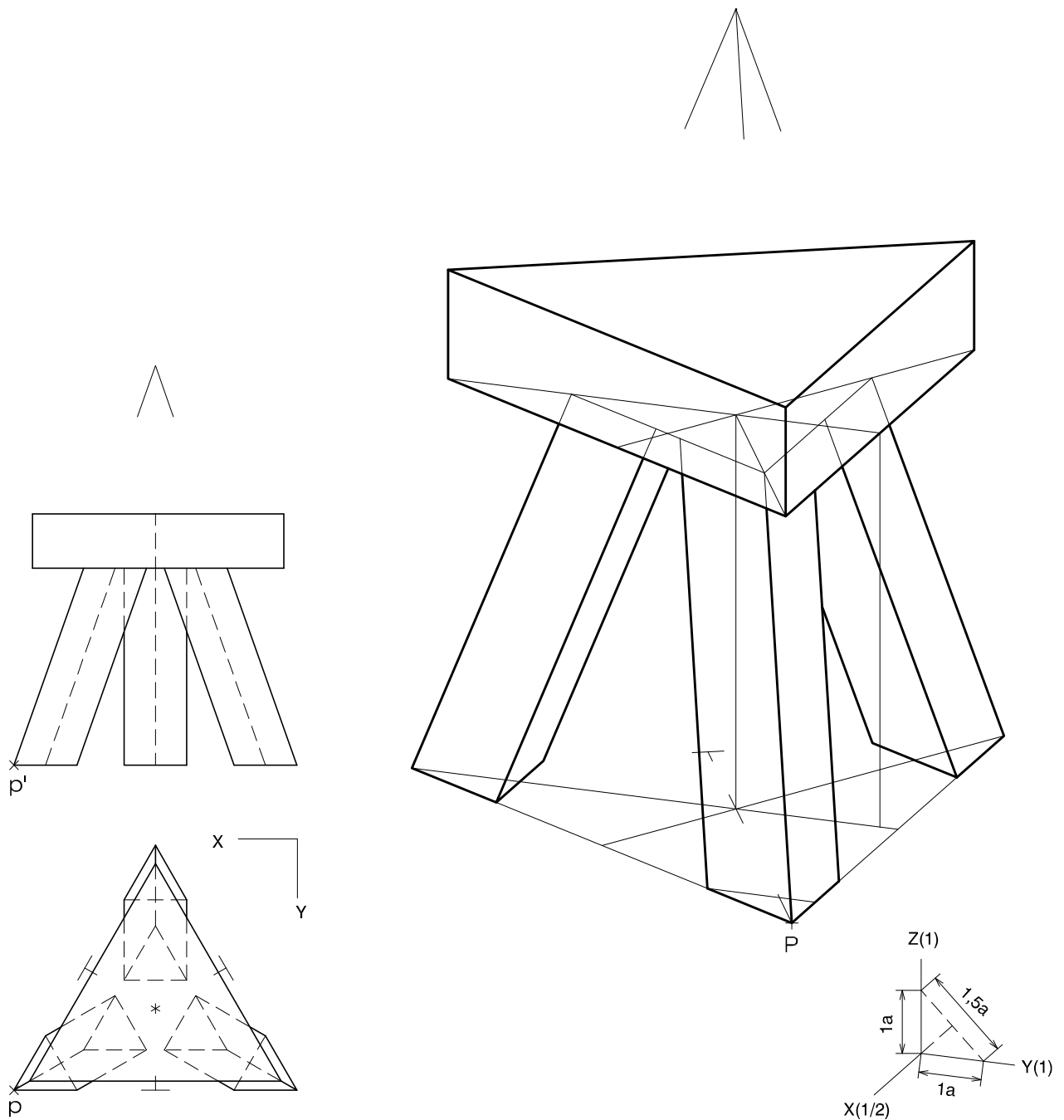
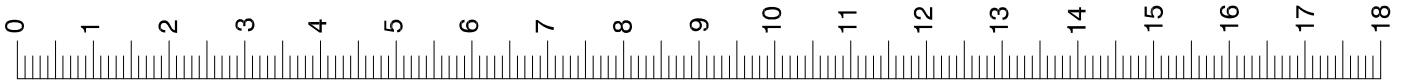

S2.3B

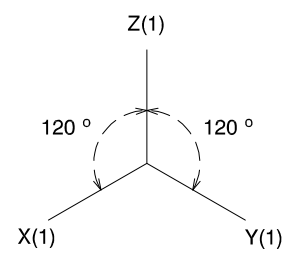
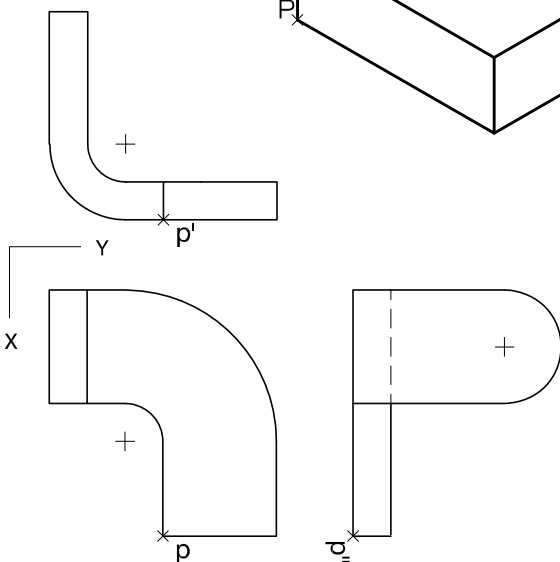
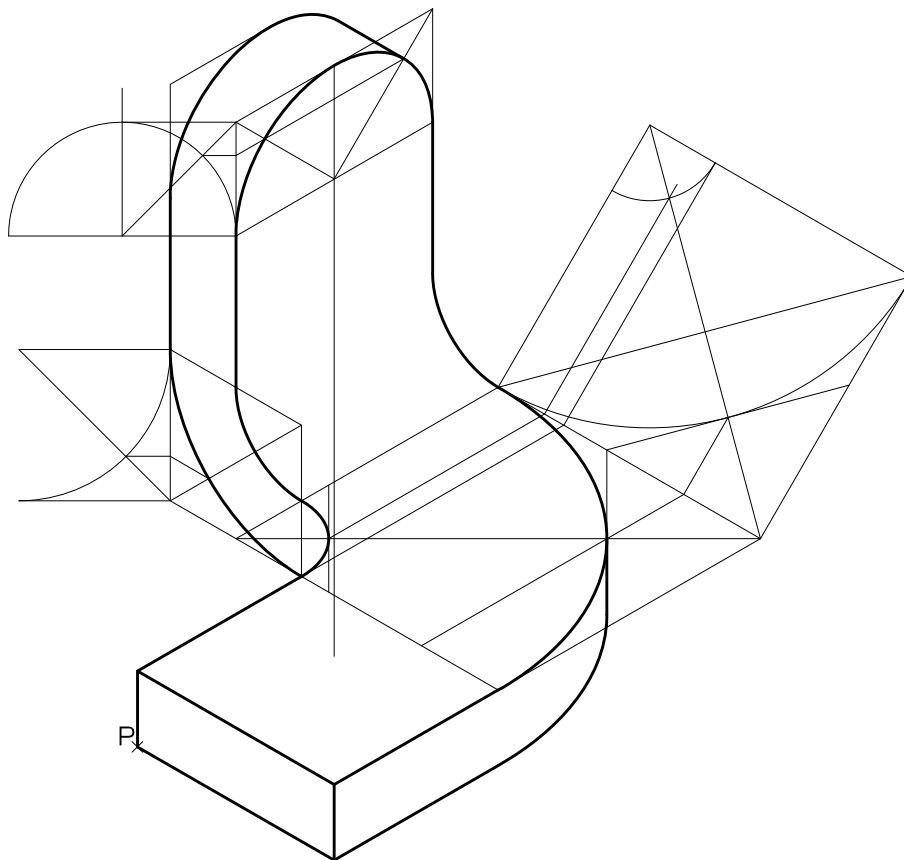
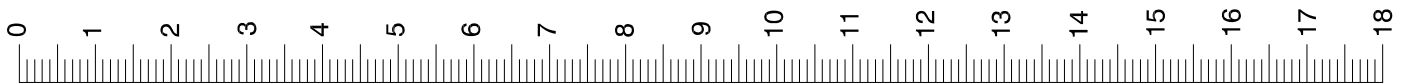

S4.3A

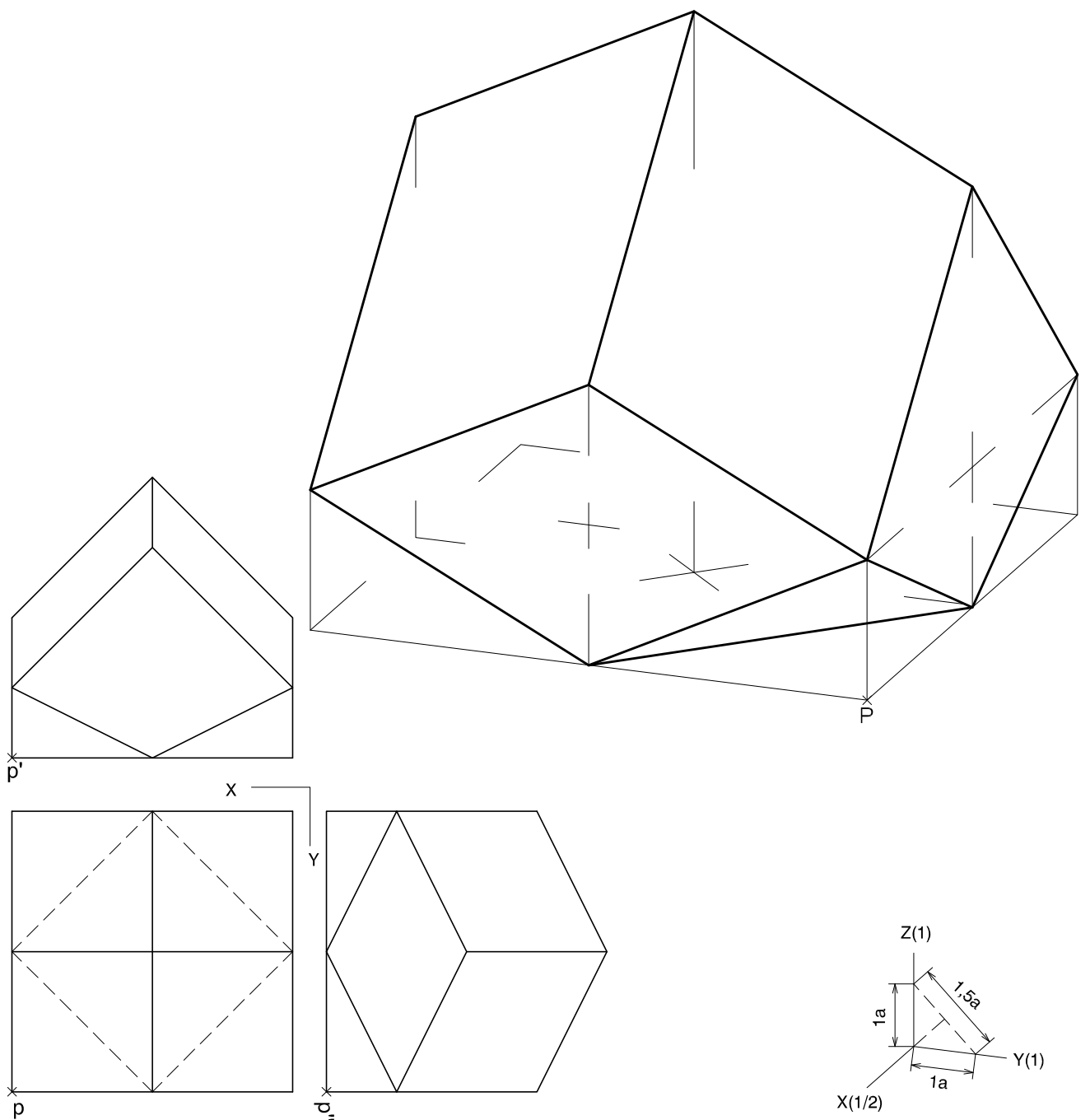
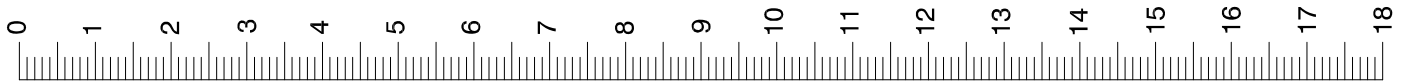

S4.3B

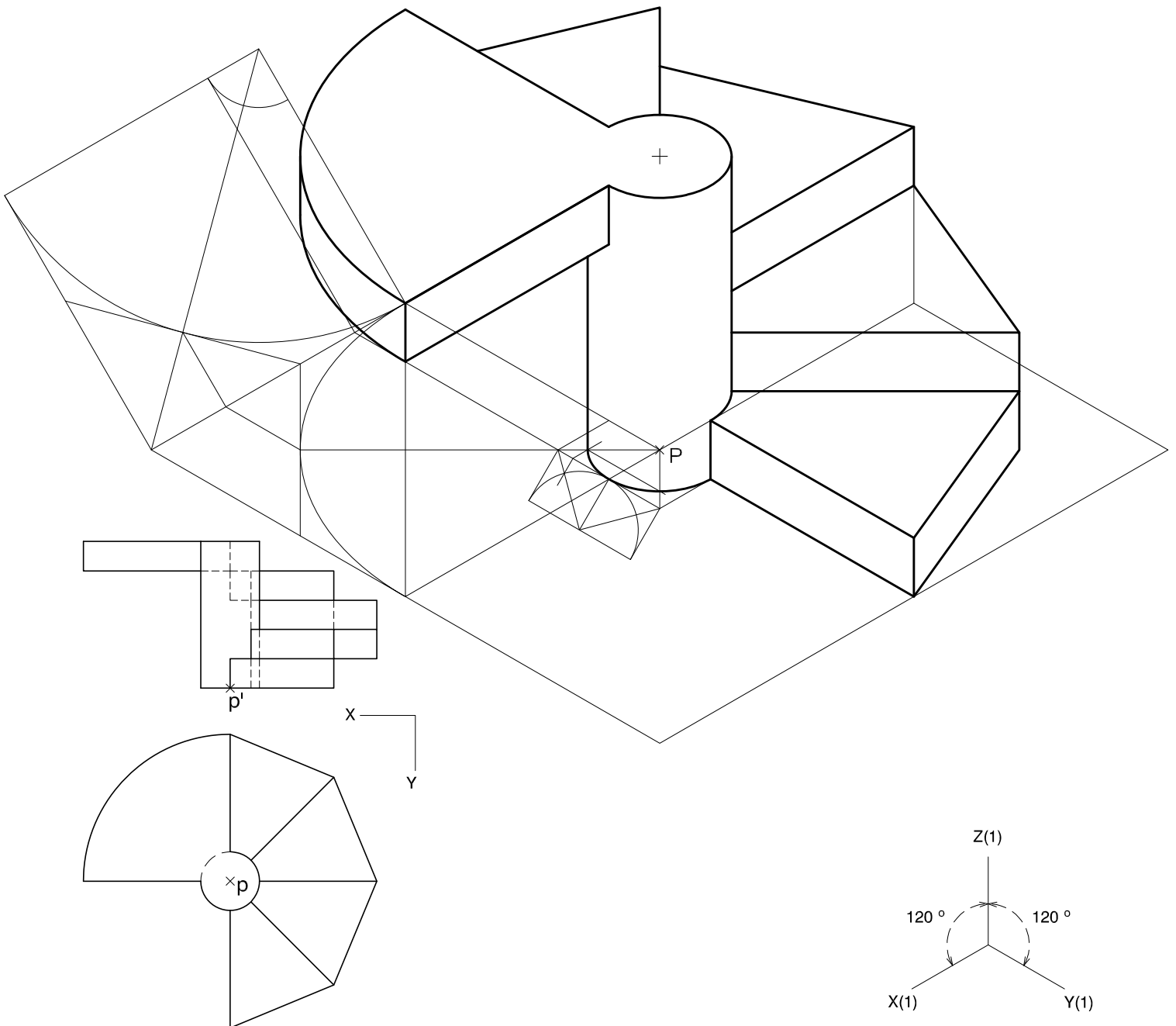
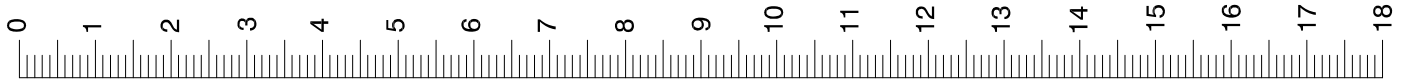

S5.3A

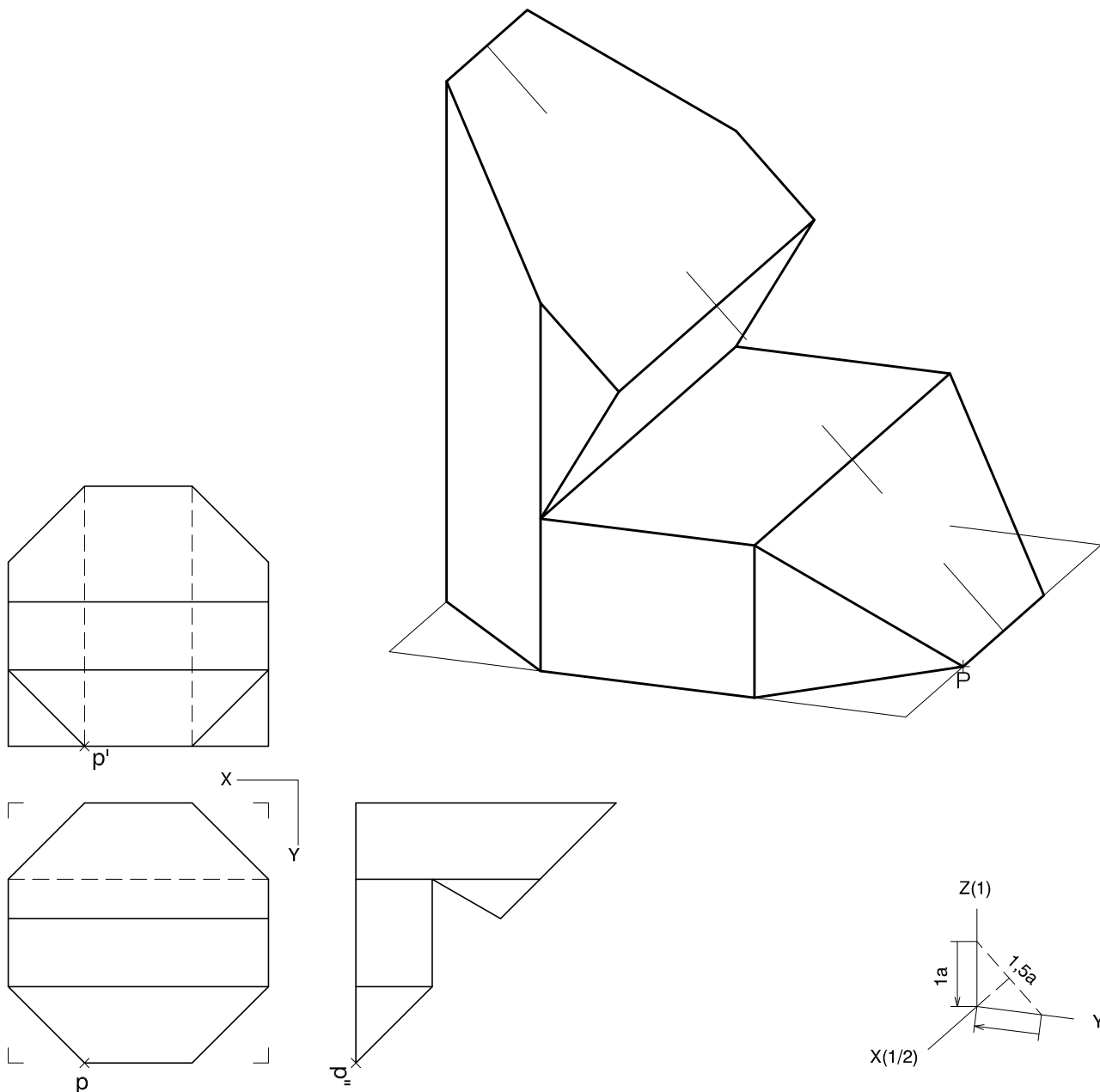

S5.3B

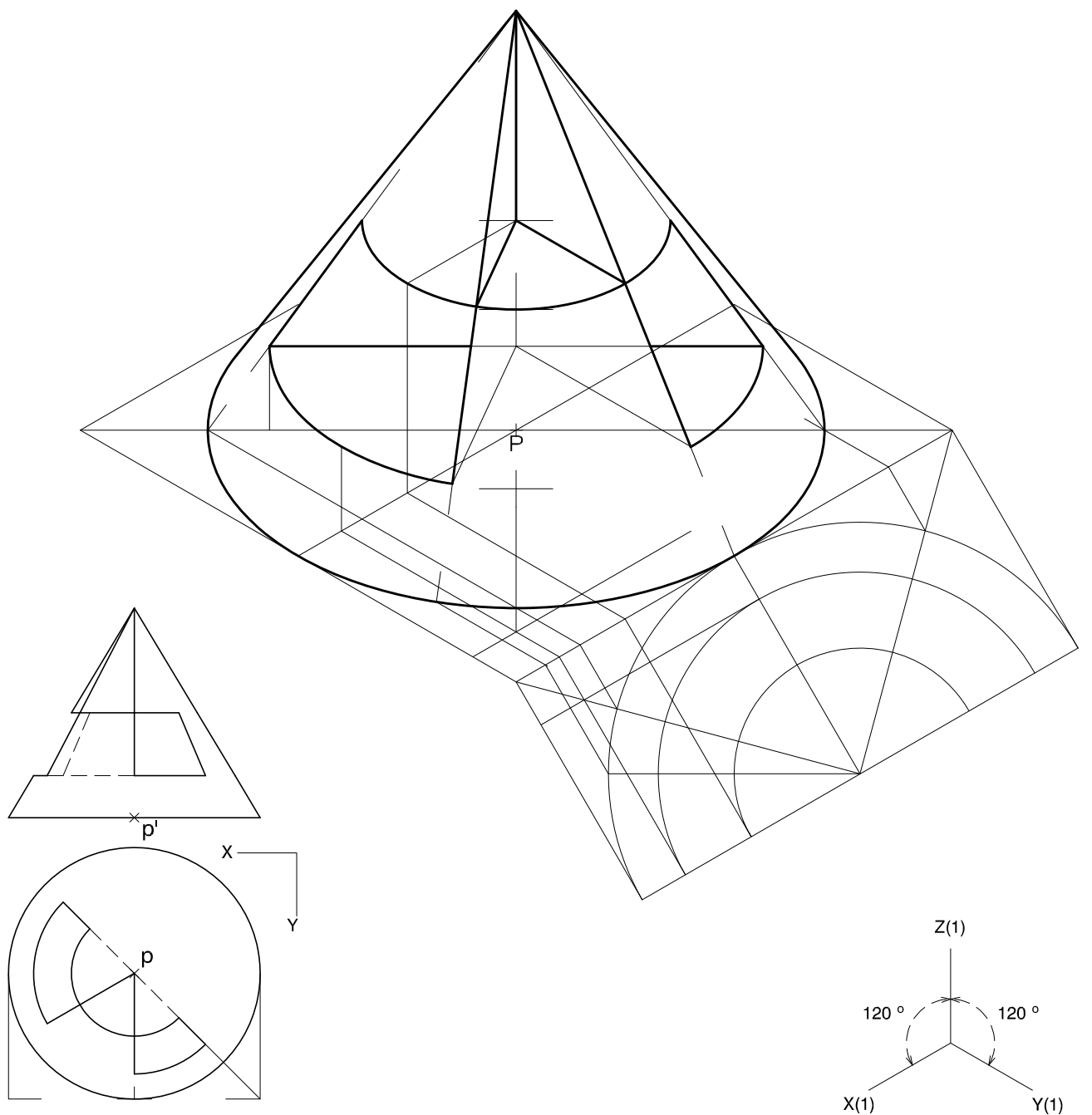
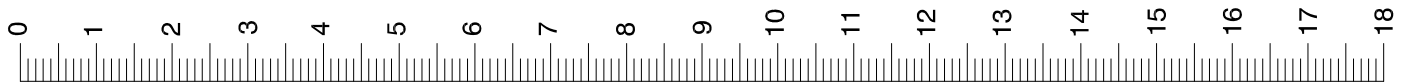

S3.3A

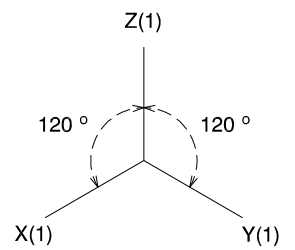
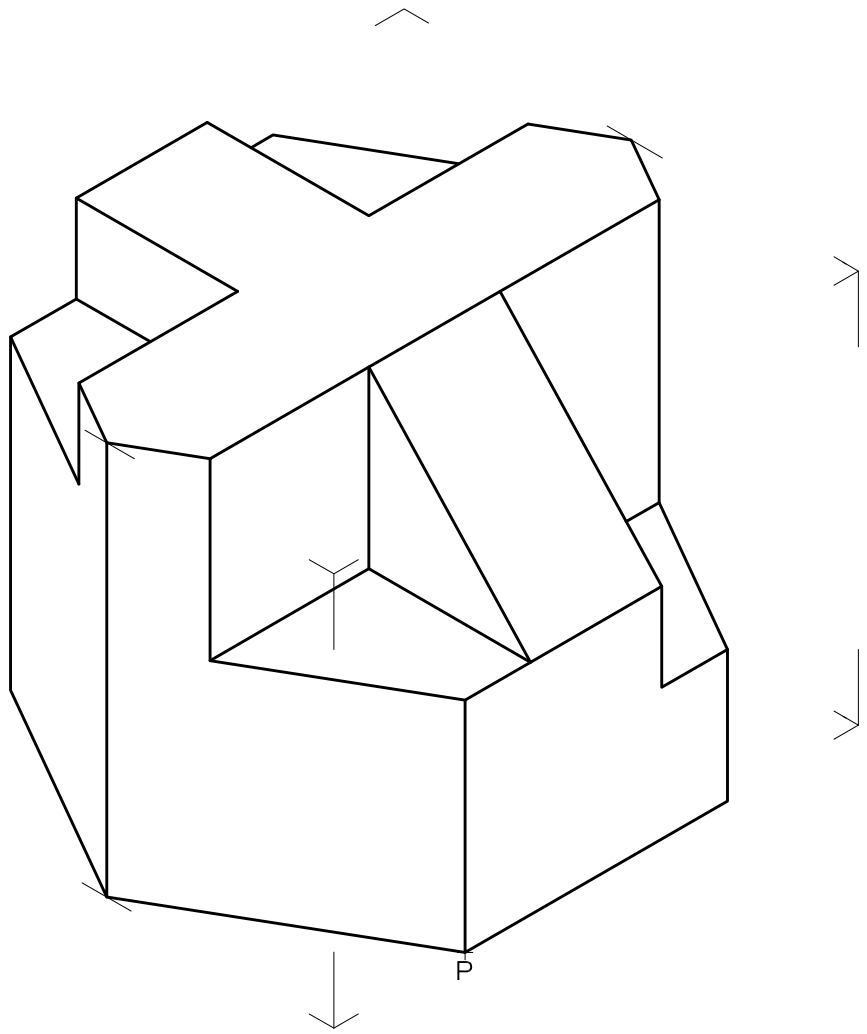
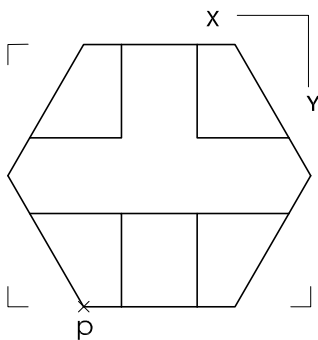
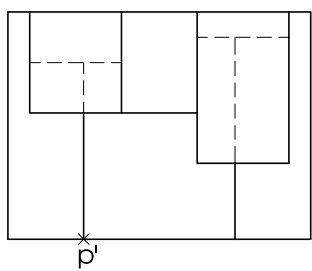
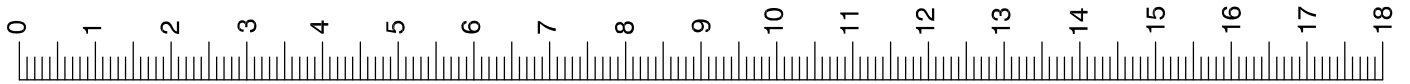

S3.3B

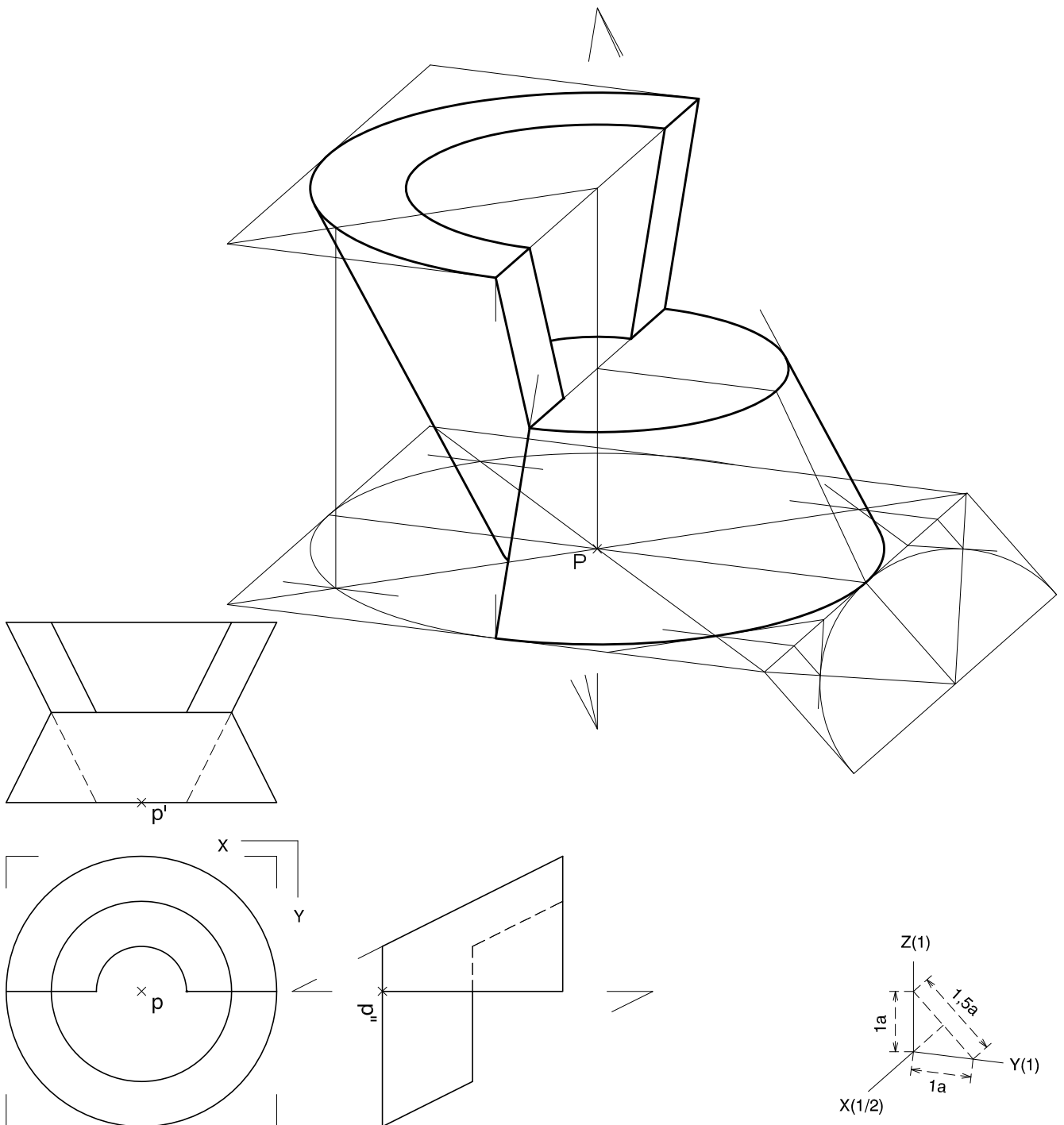
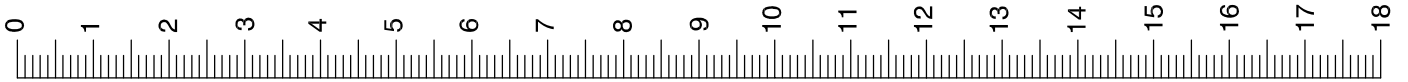

S 5.3A

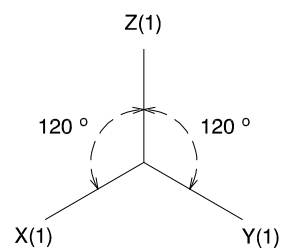
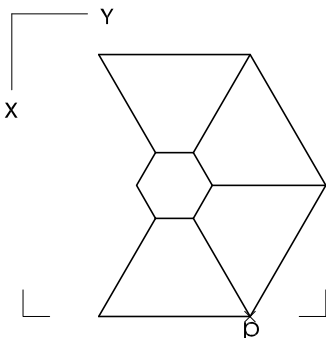
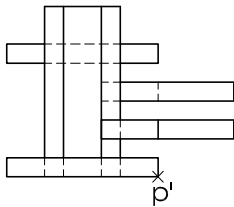
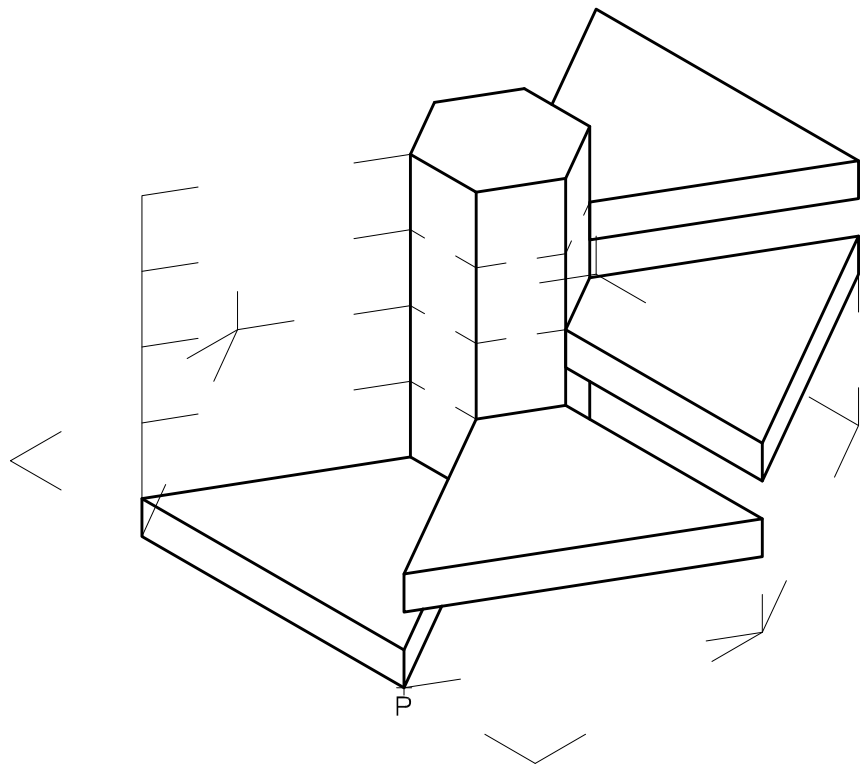
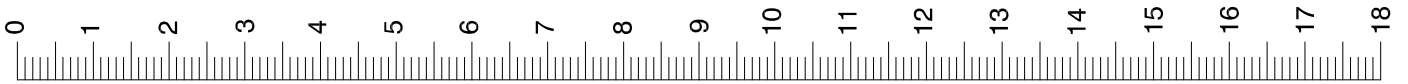

S 5.3B

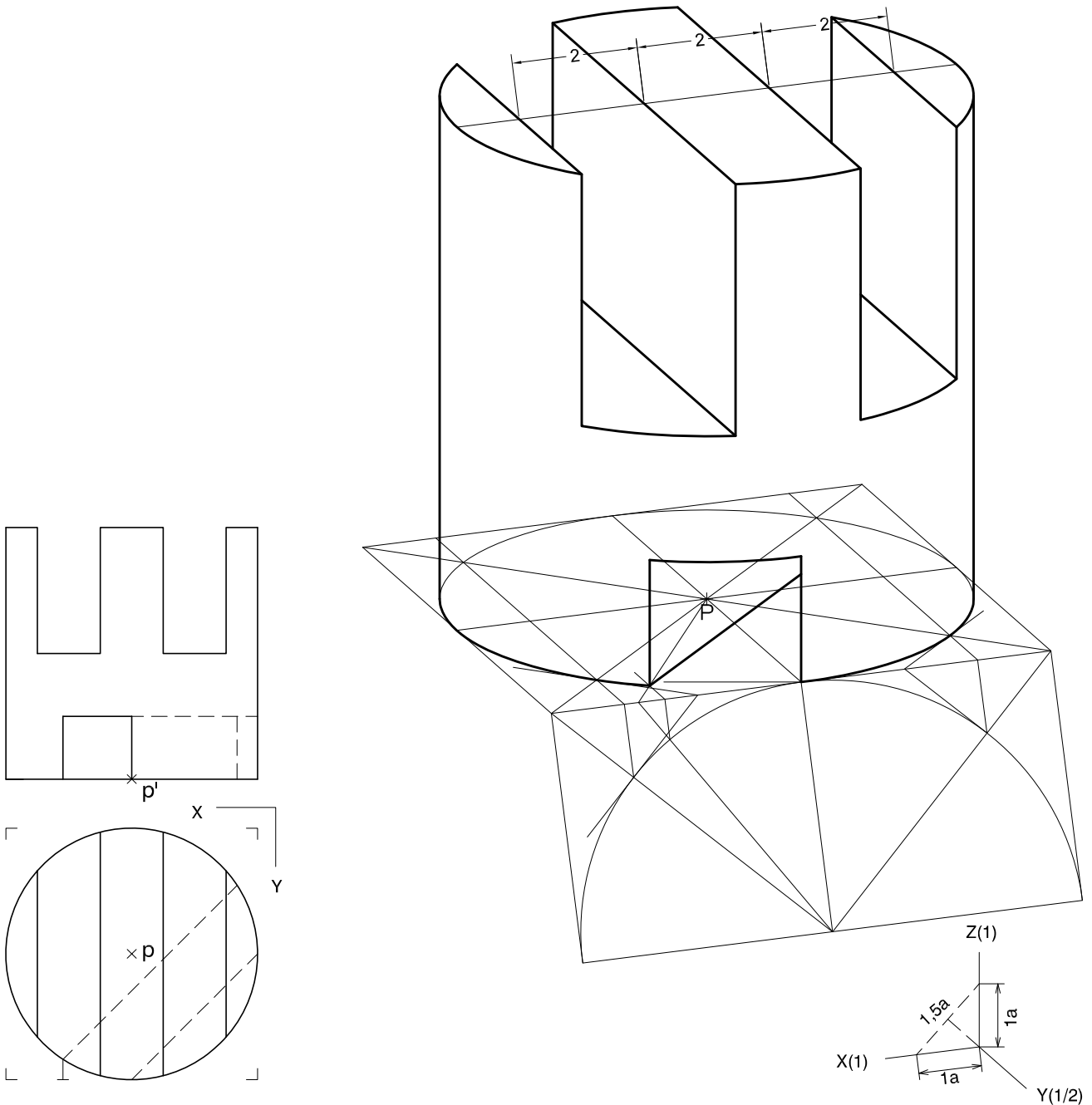
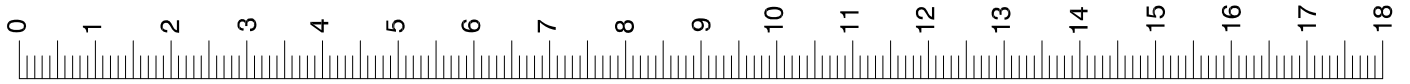

S1.3A

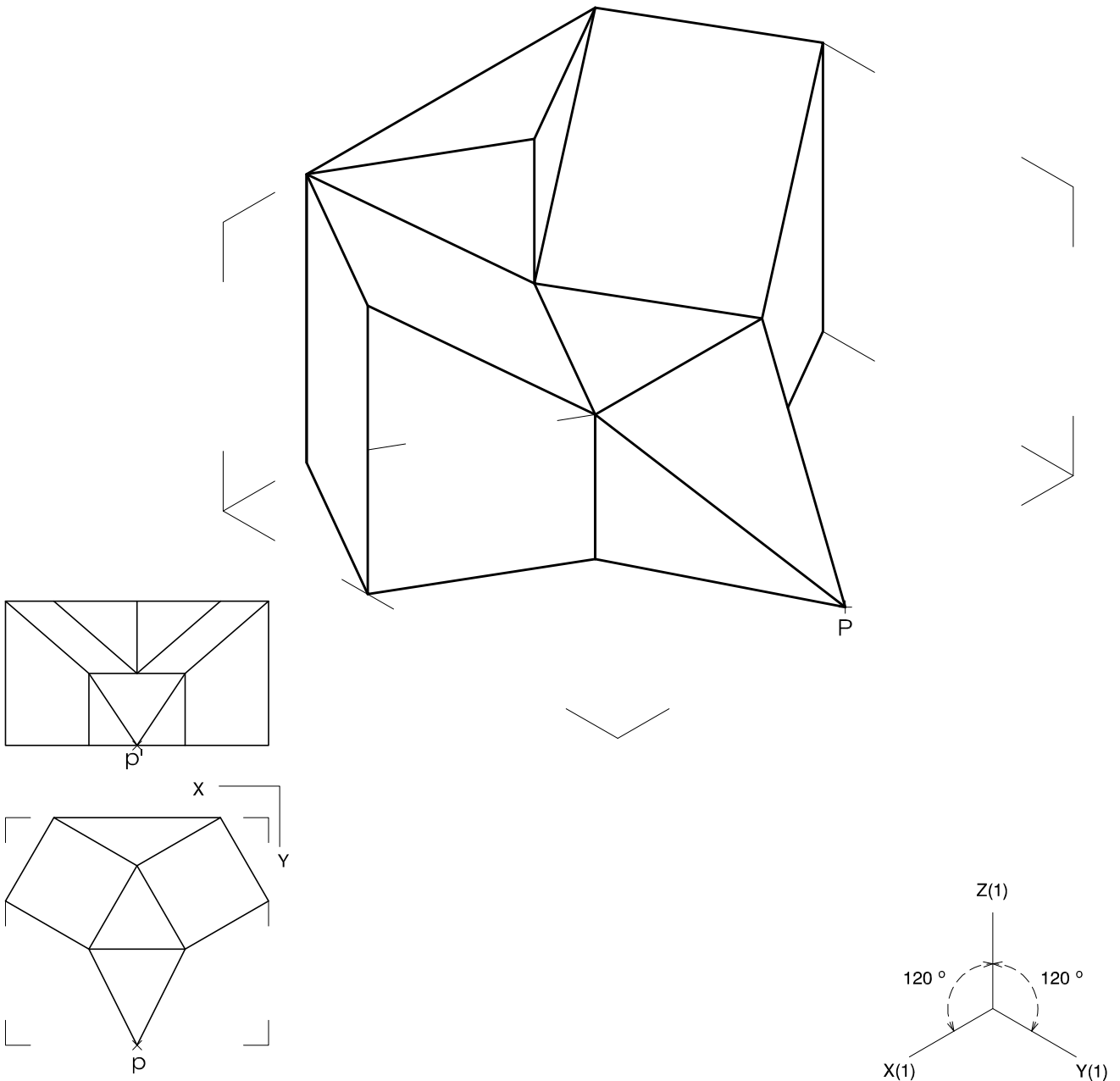
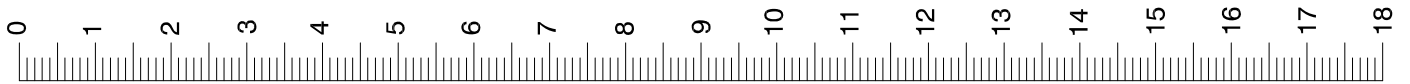

S1.3B

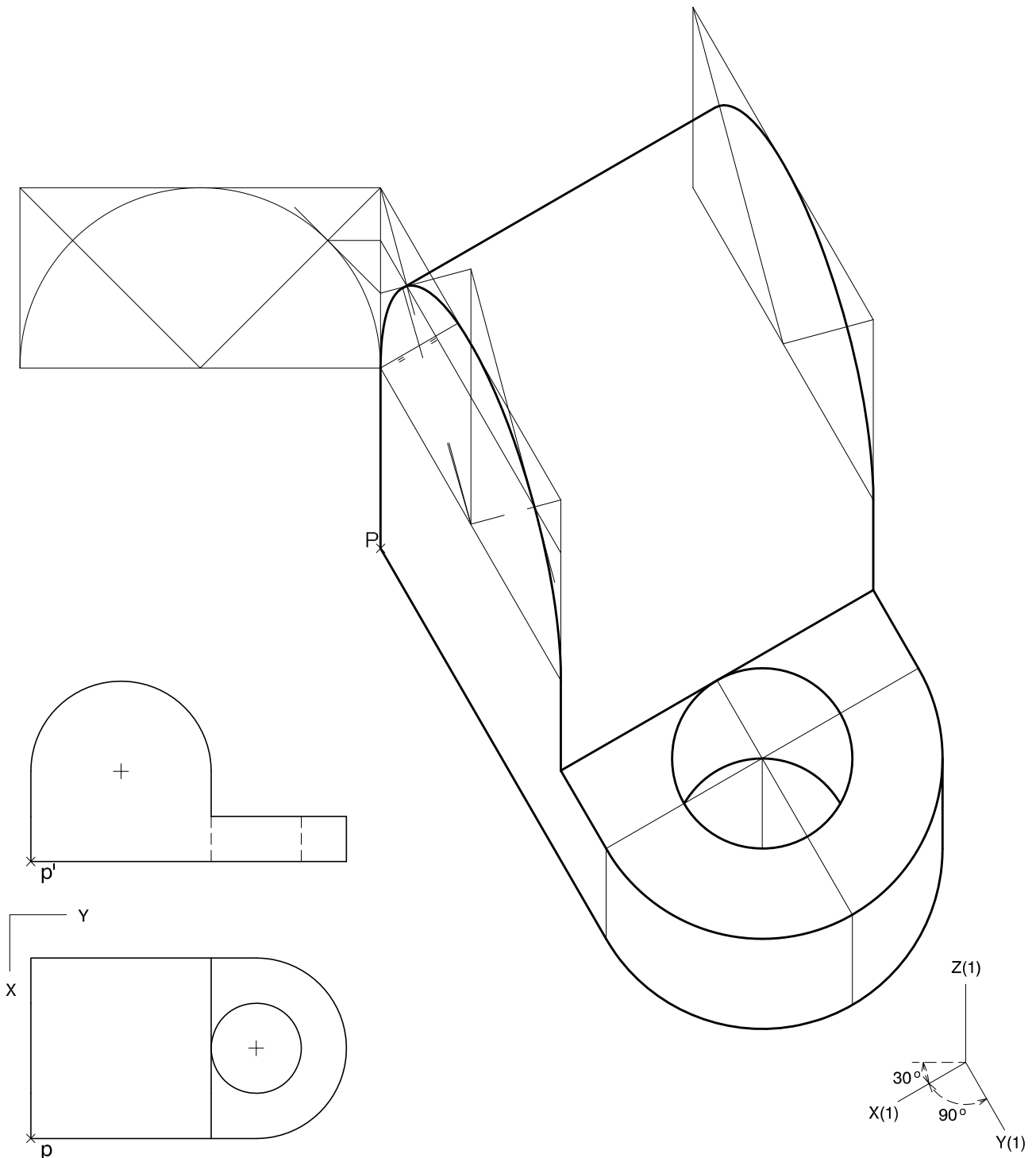

S1.3A

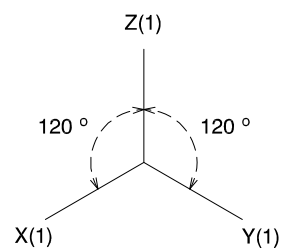
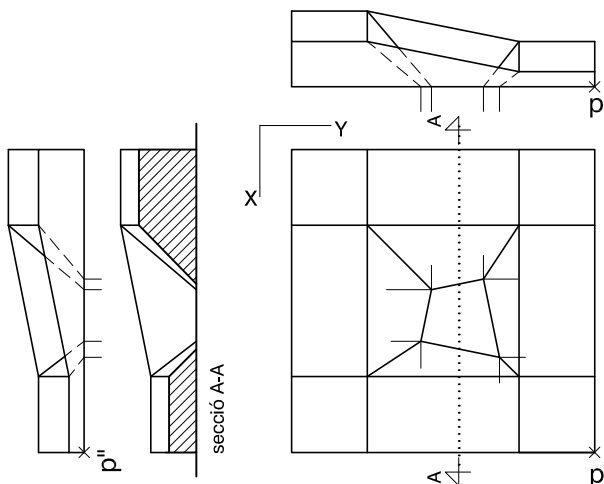
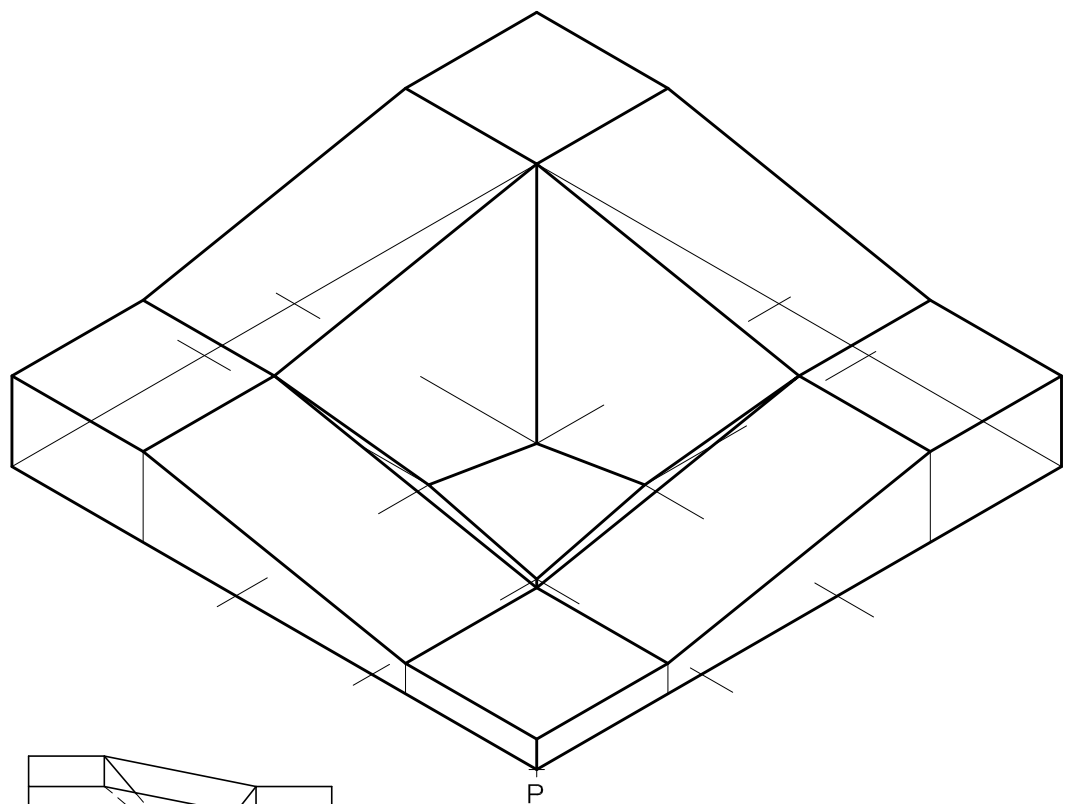
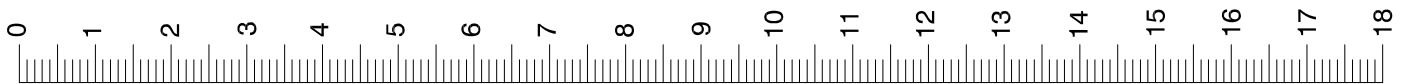

S1.3B

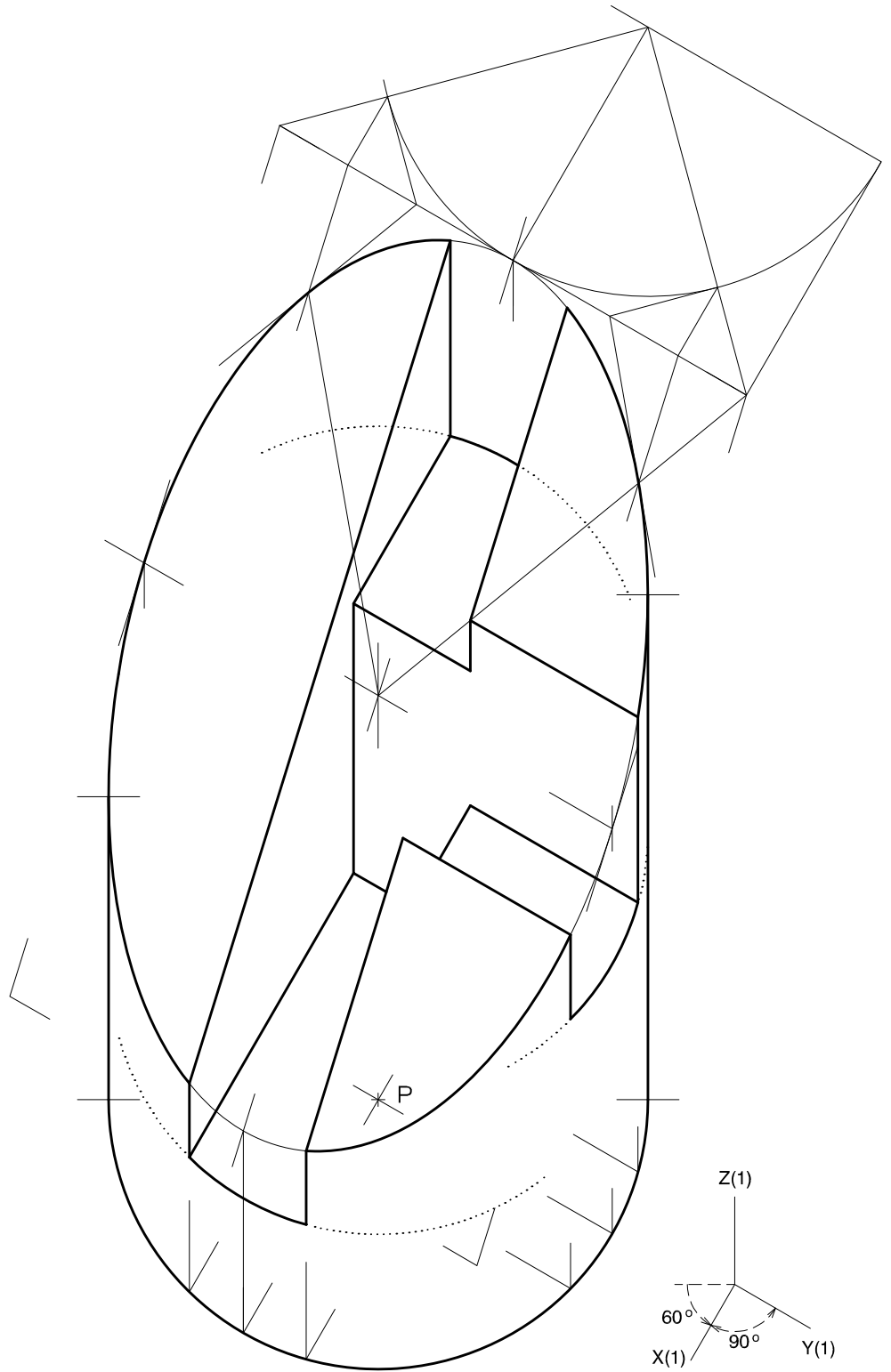
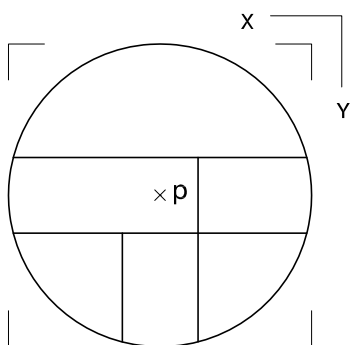
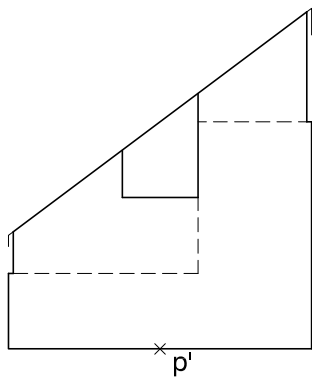

S5.3A

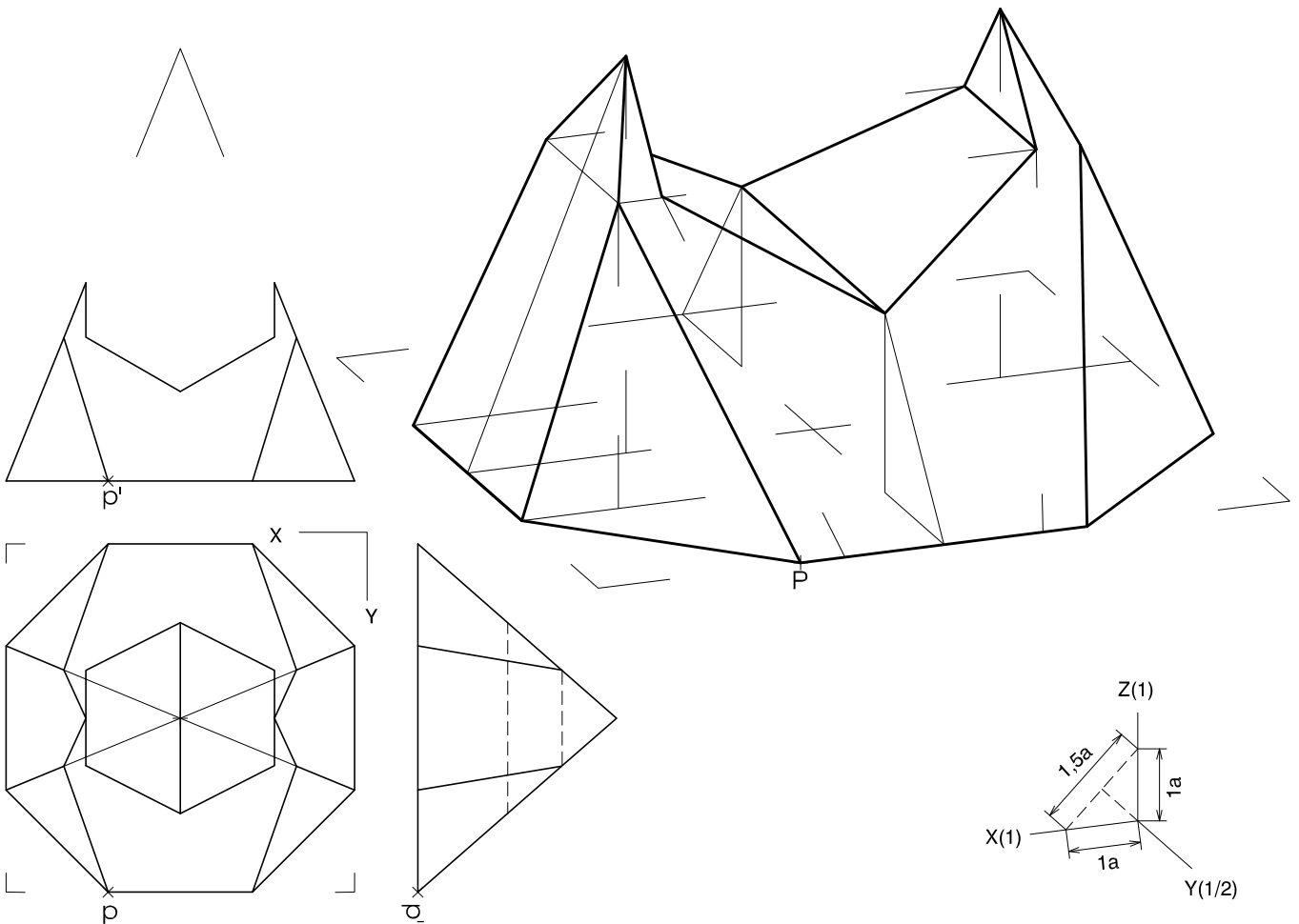
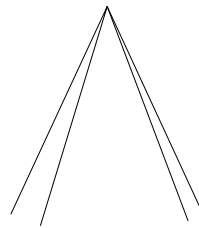
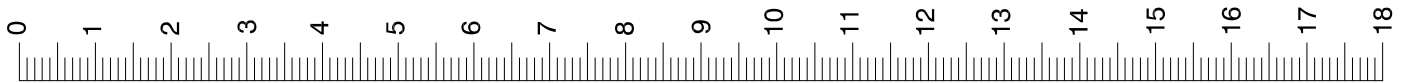

S5.3B

